

Short Vowel Pictures

“a” Pictures

ant
ax
bag
bat
cat
hand
hat
map
plant
stamp

“o” Pictures

box
dog
frog
lock
mop
pod
pond
rock
stop
top

“e” Pictures

bed
belt
hen
nest
net
pen
sled
stem
ten
tent

“u” Pictures

bud
cup
drum
duck
gum
jump
nut
skunk
sun
truck

“i” Pictures

bib
fig
fin
gift
pig
pin
six
swim
wig
zip

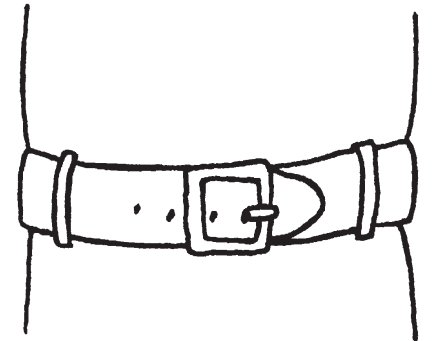
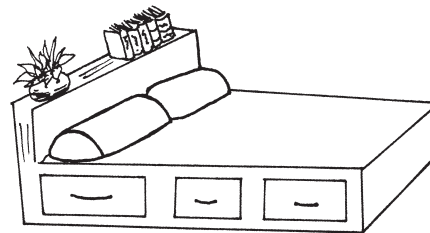
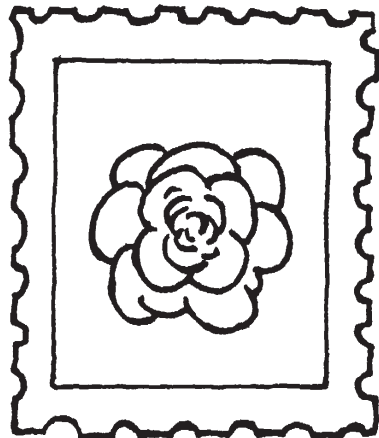
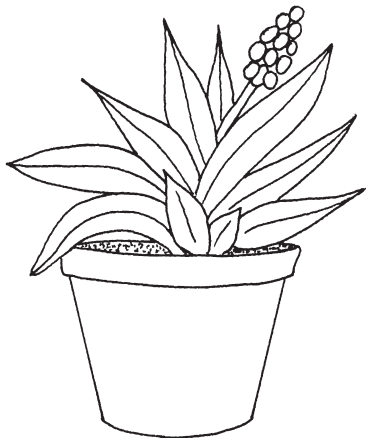
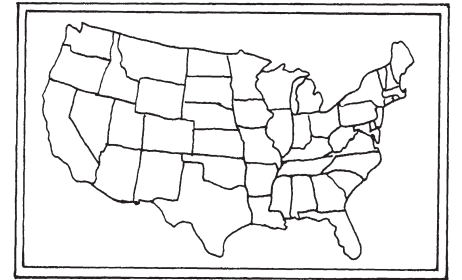
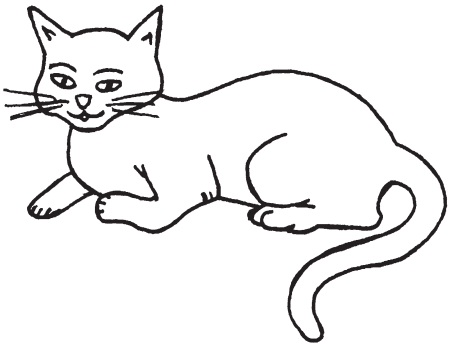
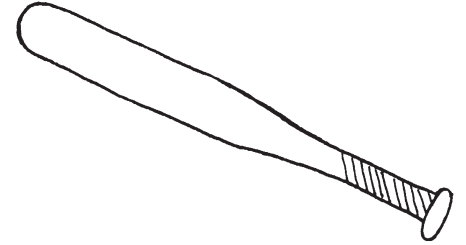
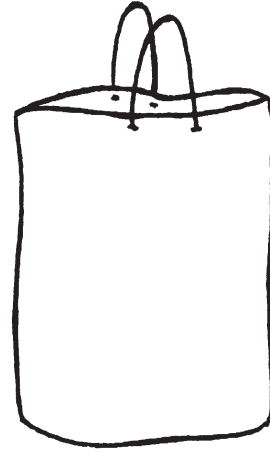
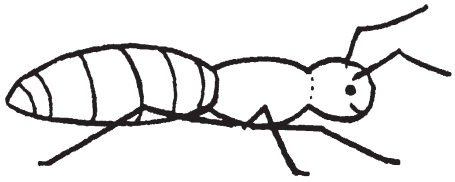

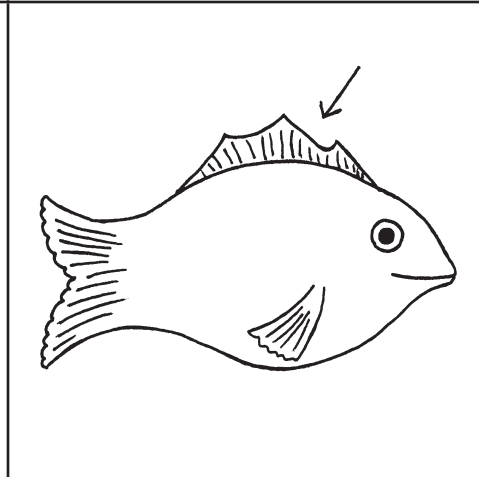
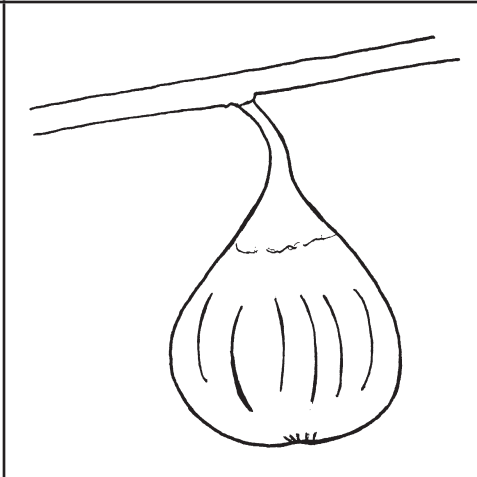
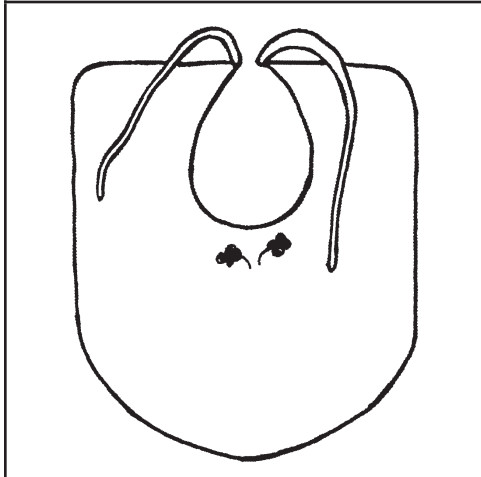
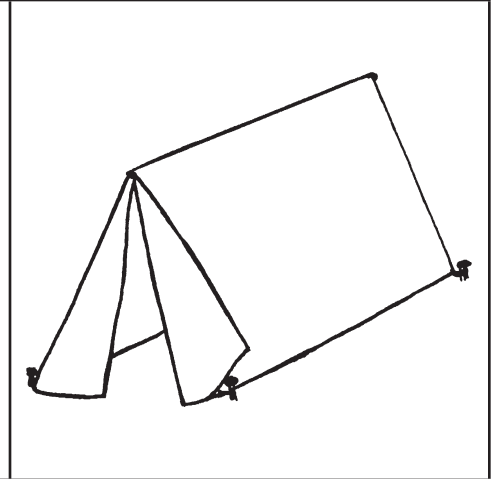
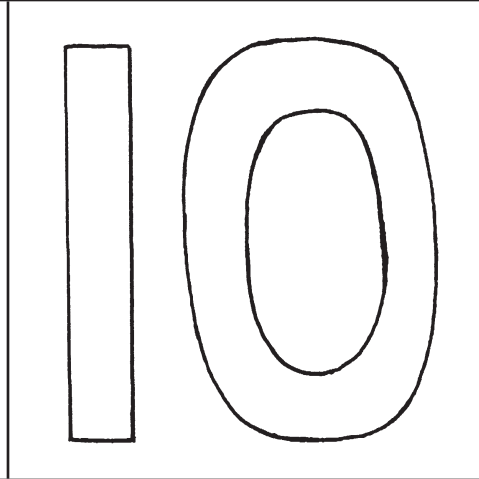
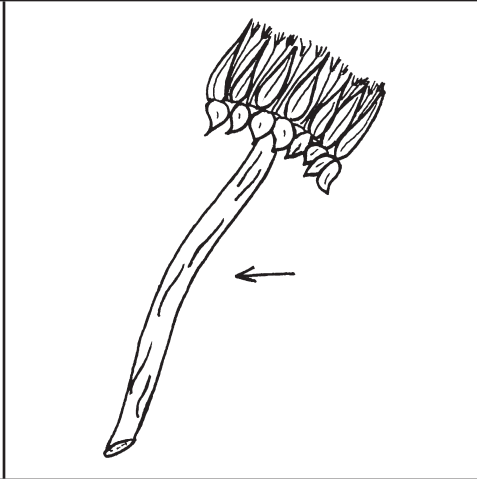
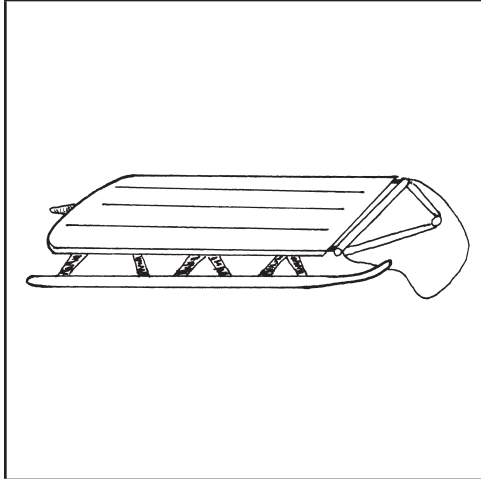
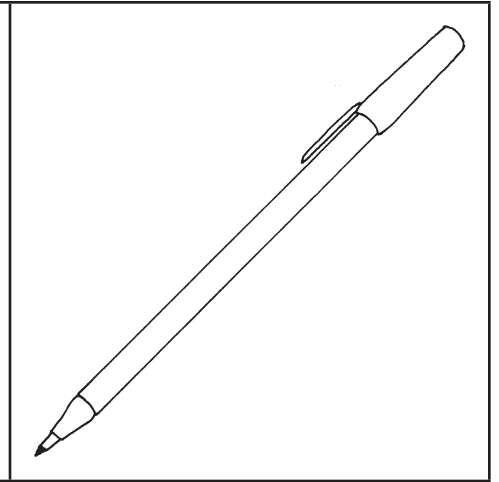
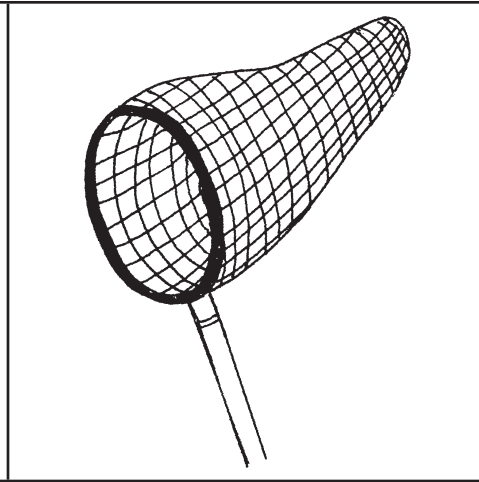
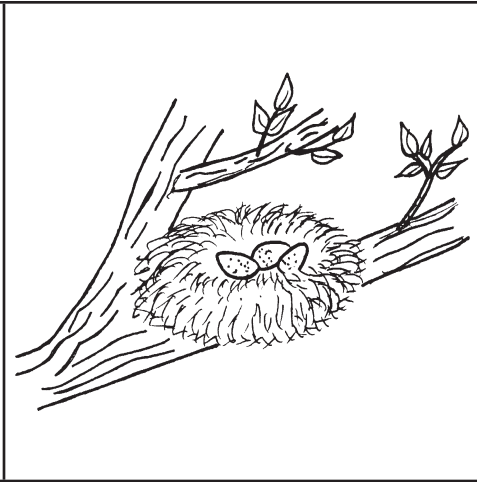
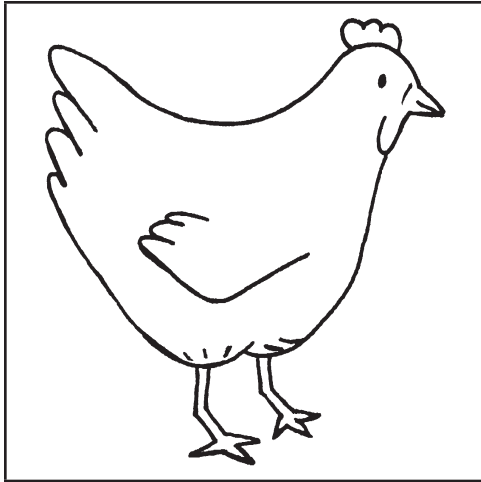

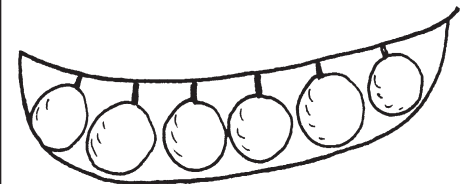
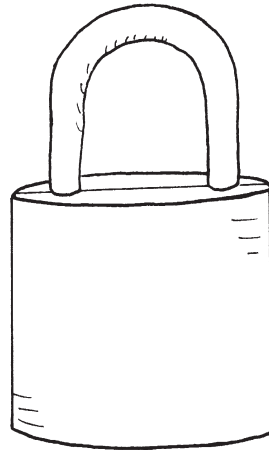
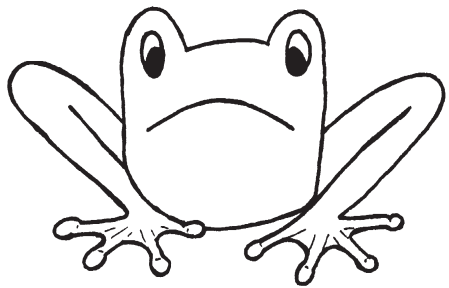
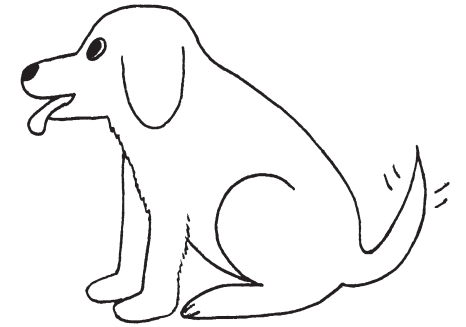
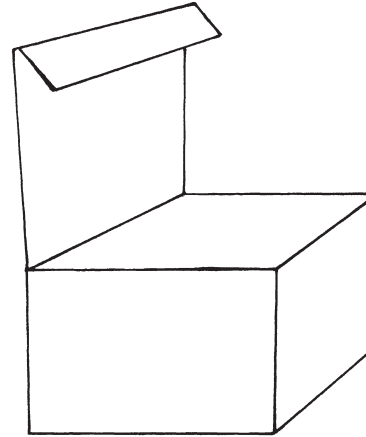
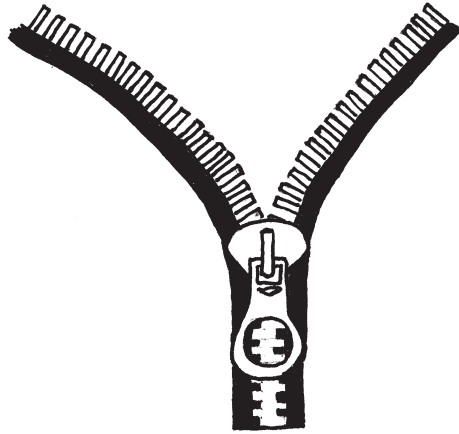
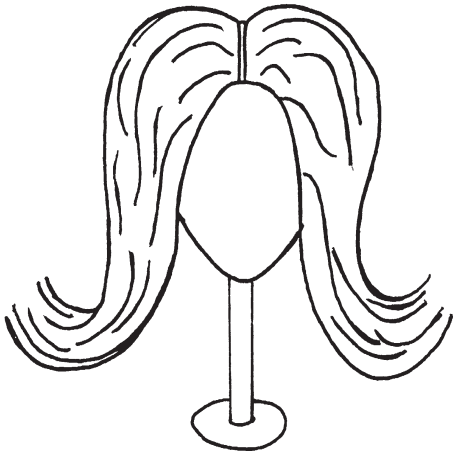
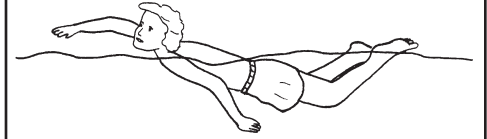
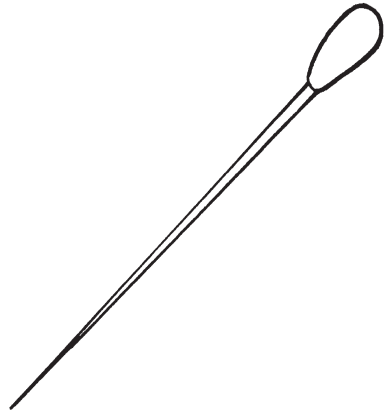
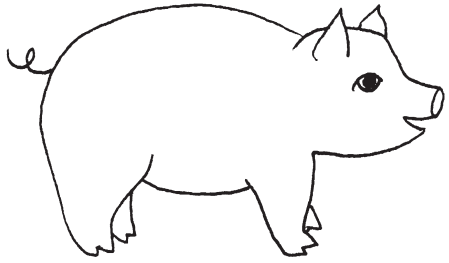

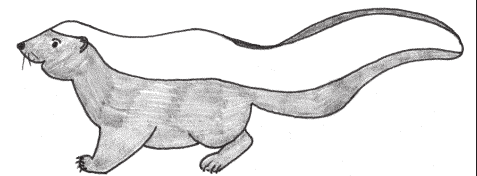
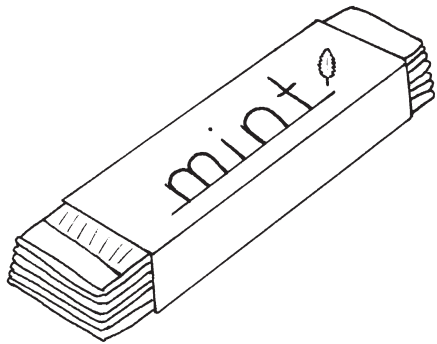
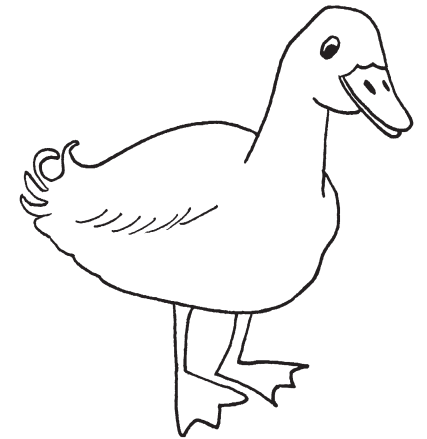
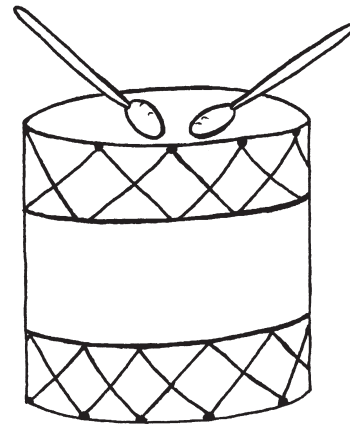
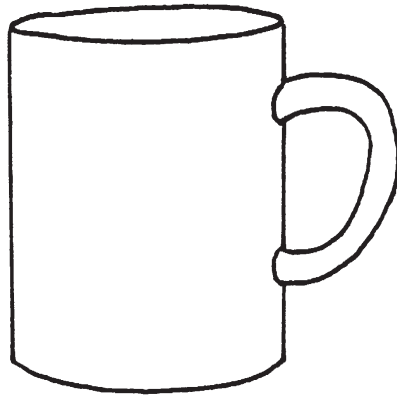
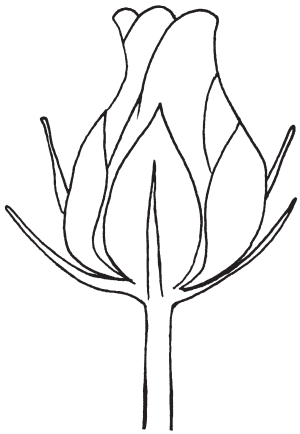
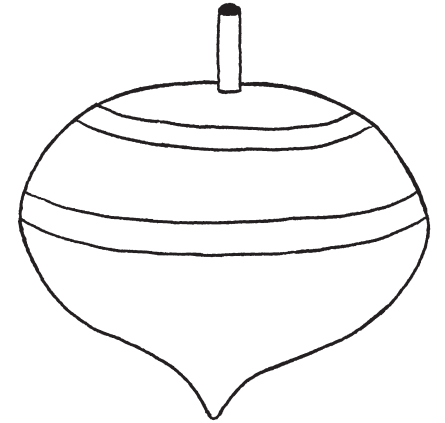
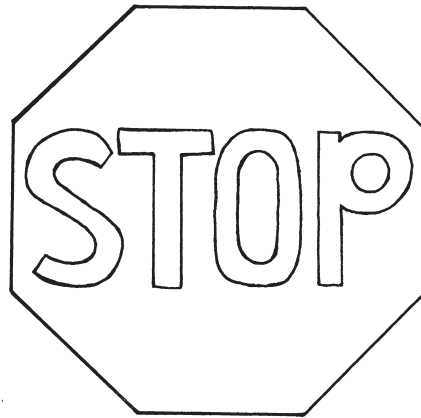
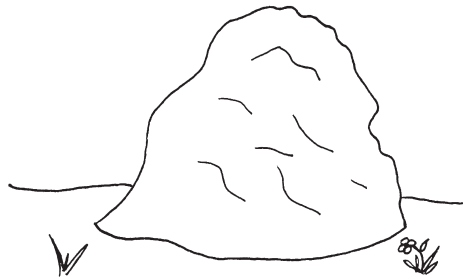
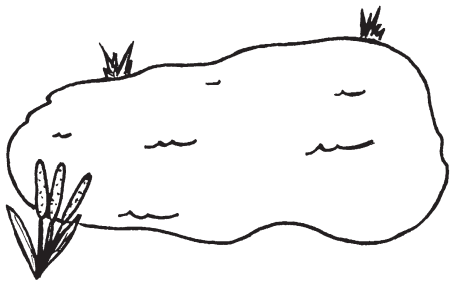

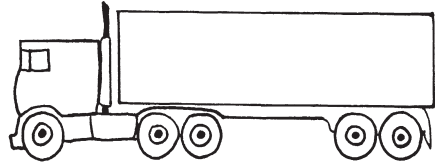
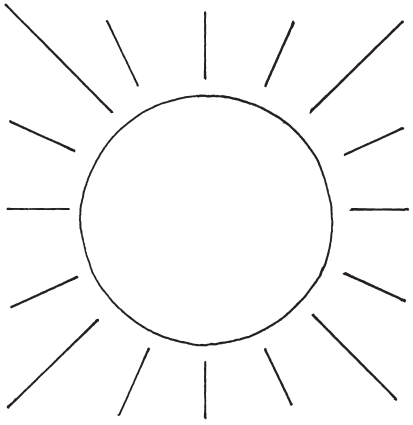

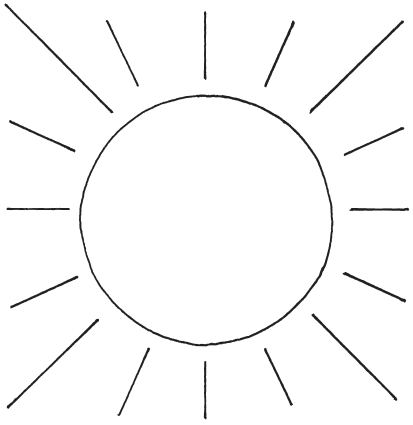
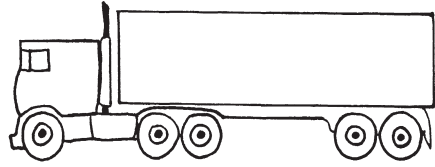
| | | | |
|---|--|--|--|
|  |  | | |
| | | | |
| | | | |